





# Indice

## Index

2	Made in Italy
4	Acqua
12	Incontro
22	Passepartout terra
28	Assolo
32	Cuboled
36	miniTensoSferico
42	TensoStilo
49	Schede tecniche Technical sheets

Da sempre Cini&Nils ha fatto della qualità uno dei suoi punti di forza. La missione da quando è nata l'azienda è puntare all'eccellenza sia nel campo della progettazione che nella produzione rigorosamente Made in Italy. Cini&Nils è una boutique creativa in cui le idee, frutto di un lungo percorso di ricerca, vengono sapientemente trasformate in prodotti dall'ufficio R&S grazie al suo know-how acquisito in decenni di esperienza. Con l'avvento della tecnologia LED evolve anche l'approccio di Cini&Nils verso la luce: si aprono nuovi scenari luminosi ottenuti attraverso continui studi di interazione fra differenti componenti e la nuova sorgente luminosa. Il valore dei prodotti Cini&Nils risiede principalmente nella sperimentazione sia a livello progettuale che produttivo. L'azienda collabora con designer le cui idee concorrono nel superare i tradizionali schemi e con fornitori italiani che condividono la stessa cura del dettaglio e la stessa voglia di intraprendere nuove strade produttive. Per questi motivi Cini&Nils è realmente parte attiva del "Made in Italy" e, allo stesso modo, creatrice di innovazione industriale nel segno dell'estetica. Alla fine del processo produttivo, ogni lampada, prima di essere immessa sul mercato, supera rigorosi controlli di qualità in modo da garantire eccellenza e alte prestazioni.

Cini&Nils has always treated quality as one of its strongest points. Ever since the firm was founded, its mission has been to focus on excellence in both its design activities and its production – all strictly Made in Italy. Cini&Nils is a creative boutique where ideas are nurtured in a long process of research, before being skilfully transformed into products by the R&D department, applying the know-how it has learned in decades of experience. With the advent of the LED technology, Cini&Nils' approach to lighting has also evolved, opening up new lighting scenarios devised in continuous studies of how different components interact with the new source of illumination. The most valuable facet of Cini&Nils products is their basis in experimentation in both design and production. The firm partners with designers whose ideas contribute to breaking out of traditional strategies and with Italian suppliers who share the same dedication to detail and the same desire to venture along new paths of production. This explains why Cini&Nils is a truly active part of Made in Italy and, at the same time, a creator of industrial innovation

inspired by aesthetics. At the end of the production process, every lamp has to pass strict quality tests before being sent to the market, so as to guarantee its excellence and high performance.

Seit jeher setzt Cini&Nils rückhaltlos auf Qualität. Schon seit der Entstehung unseres Unternehmens sind Exzellenz im Design und eine komplett italienische Produktion unsere Grundpfeiler. Cini&Nils ist eine Kreativwerkstatt, in der über lange Zeit herangereifte Ideen mit Hilfe unserer Entwicklungsabteilung und ihrem über Jahrzehnte erworbenen Know-how zu herausragenden Produkten verwandelt werden. Mit dem Aufkommen der LED-Technologie hat sich auch die Einstellung von Cini&Nils zum Lichtdesign weiterentwickelt: Dank unserer fortlaufenden Forschungsarbeit eröffnen sich immer wieder neue Horizonte für die Kombination dieses Leuchtmittels mit verschiedenen Bauteilen und Materialien. Der besondere Wert der Cini&Nils Produkte liegt vor allem in den zukunftsweisenden Szenarien, die sie sowohl im Design wie in der Produktionstechnik erschaffen. Cini&Nils arbeitet mit Designern zusammen, die mit ihren Ideen die altbekannten Grenzen überwinden, sowie mit italienischen Zulieferern, die sich in puncto Perfektionismus und Innovation von der selben Leidenschaft leiten lassen wie wir. Somit ist Cini&Nils ein wahrhafter Vertreter des „Made in Italy“ und gleichermaßen ein Vorreiter der industriellen Innovation im Zeichen der Ästhetik. Am Ende des Fertigungsprozesses wird jede unserer Leuchten einer strengen Qualitätskontrolle unterzogen, damit sie Exzellenz und maximales Leistungsvermögen garantiert.

Depuis toujours Cini&Nils a fait de la qualité un de ses points de force. Sa mission depuis sa naissance est de viser à l'excellence soit dans le champ du projet que dans celui de la production rigoureusement Made in Italy. Cini&Nils est une boutique créative où les idées, fruit d'un long parcours de recherche sont savamment transformées en produits par le bureau R&S, grâce à son know-how acquis par une expérience de plusieurs décennies. Avec l'avènement de la technologie LED, l'approche de Cini&Nils s'oriente aussi vers la lumière avec de nouveaux scénarios d'éclairage, obtenus grâce aux études continues d'interaction entre les différentes composantes et la

# Made in Italy

nouvelle source lumineuse. La valeur des produits Cini&Nils réside principalement dans l'expérimentation dans le processus du projet et de la production. L'entreprise cultive sa collaboration avec de prestigieux designers, proposant le dépassement des schémas traditionnels et avec des fournisseurs italiens partageant le même soin du détail et la même envie d'entreprendre de nouvelles voies productives. Pour ces motifs Cini&Nils a un rôle réellement actif dans le "Made in Italy" et est aussi créatrice d'innovation industrielle dans le signe de l'esthétique. À la fin du processus de production chaque lampe, avant d'être introduite sur le marché a passé avec succès la rigoureuse procédure de tests de contrôle de qualité pour en garantir l'excellence et les plus hautes performances.

Desde siempre Cini&Nils ha hecho de la calidad uno de sus puntos fuertes. La misión, desde cuando se fundó la empresa, es apuntar hacia la excelencia, tanto en el campo del proyecto como en la producción rigurosamente Made in Italy. Cini&Nils es una boutique creativa en que las ideas, fruto de un largo camino de investigación, son transformadas con gran sabiduría en productos por el departamento de I&D gracias a su know-how adquirido en decenas de años de experiencia. Con la llegada de la tecnología LED progresa también el enfoque de Cini&Nils respecto a la luz: se abren nuevos escenarios luminosos obtenidos a través de continuos estudios de interacción entre diferentes componentes y la nueva fuente luminosa. El valor de los productos Cini&Nils está principalmente en su experimentación, tanto a nivel de proyecto como productivo. La compañía colabora con diseñadores cuyas ideas contribuyen a superar los esquemas tradicionales, y con proveedores italianos que comparten el mismo esmero por el detalle y el mismo deseo de explorar nuevos rumbos productivos. Por estas razones Cini&Nils es realmente parte activa del "Made in Italy" y, al mismo tiempo, creadora de innovación industrial en el nombre de la estética. Al final del proceso productivo cada lámpara, antes de ser lanzada al mercado, supera estrictos controles de calidad de modo de garantizar excelencia y altas prestaciones.

# Acqua

Luta Bettonica, 2014

Acqua si arricchisce di nuove finiture come l'oro e l'argento opaco effetto anodizzato, e come foglia oro e argento dal classico effetto materico e screpolato dato dai fogli in oro e argento puro applicati manualmente su ogni singolo pezzo. Acqua ha ricevuto tre riconoscimenti internazionali: il Miaw ai Muuuz International Awards 2015 nella categoria Lighting, la Menzione Speciale al Premio Codega 2016, il Best of Category Lighting agli Archiproducts Design Awards 2016.

Acqua bursts back on the scene with new finishes, including matt gold and silver with an anodised look and gold or silver leaf with the classical peeling effect of the material that comes when pure gold or silver leaf is applied to each individual piece by hand. Acqua has won three international awards: the 2015 Miaw at the Muuuz International Awards in the Lighting category, a Special Mention at the 2016 Codega Award and the Best of Lighting Category at the 2016 Archiproducts Design Awards.

Acqua wird nun durch neue Ausführungen erweitert, wie Gold und Mattsilber mit Eloxierereffekt sowie Gold- und Silberblatt mit klassischem, rissigen Struktureffekt, der durch die Blätter aus reinem Gold und Silber entsteht, die einzeln von Hand aufgetragen werden. Acqua wurde mit drei internationalen Design-Preisen ausgezeichnet: dem MIAW-Preis der MUUUZ International Awards 2015 in der Kategorie Lighting, einer besonderen Erwähnung beim CODEGA-Preis 2016 sowie dem Preis Best of Category Lighting bei den Archiproducts Design Awards 2016.

Acqua s'enrichit de nouvelles finitions en or et argent effet anodisé opaque, et de feuille en or et argent au classique aspect matérique et craquelé résultant des feuilles en or et argent pur appliqués manuellement sur chaque pièce. Acqua a reçu trois prix internationaux: le Miaw aux Muuuz International Awards 2015 dans la catégorie Lighting, la Mention Spéciale au Prix Codega 2016, le Best of Category Lighting aux Archiproducts Design Awards 2016.

Acqua se enriquece con nuevos acabados como el dorado y el plateado mate con efecto anodizado, y como hojas de oro y plata con el clásico efecto matérico y resquebrajado dado por la aplicación manual de láminas de oro y de plata pura en cada una de las piezas. Acqua ha recibido tres reconocimientos internacionales: el Miaw en los Muuuz International Awards 2015 en la categoría Lighting, la Mención especial en el Premio Codega 2016 y el Best of Category Lighting en los Archiproducts Design Awards 2016.







Acqua uno rosone + Acqua corpo  
illuminante uplight (x8) in matt gold





Acqua tre rosone + Acqua corpo  
illuminante uplight (x8) in matt silver





Acqua rosone incasso (x13) + Acqua corpo  
illuminante uplight (x4) + Acqua corpo illuminante  
downlight (x10) in matt gold



Acqua due rosone + Acqua corpo  
illuminante uplight (x3) in silver leaf

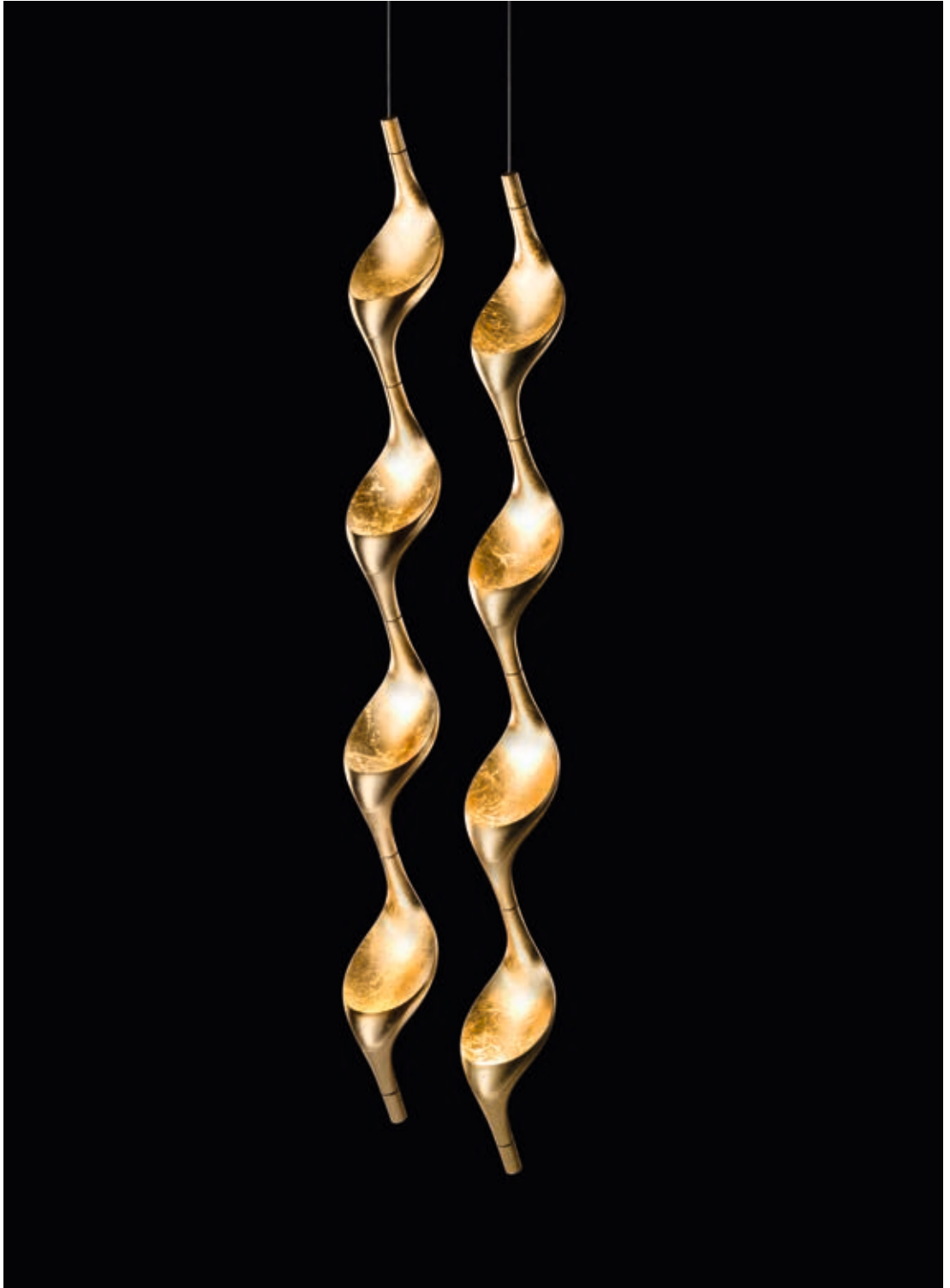

Acqua due rosone + Acqua corpo  
illuminante uplight (x8) in gold leaf

# Incontro

Luta Bettonica, 2015

Incontro è caratterizzata da due lingue estroflesse in metallo laccato che si incontrano sottili e parallele alle loro estremità. La sorgente led mai visibile rende possibile l'installazione a parete e plafone a qualsiasi altezza e in qualsiasi direzione. L'orientamento alternato o mono-direzione delle installazioni in serie crea movimento e permette di accentuare zone di plafone e/o di parete. Emette luce riflessa e indiretta ed è disponibile nelle finiture bianco, oro opaco, argento opaco e in versione on-off o dimmerabile.

Incontro features a combination of two slim lacquered metal tabs that splay outwards in parallel and come to meet at their extremities. The LED light source is never visible and enables the lamp to be installed at any height on the wall or ceiling and pointing in any direction. The alternating or single-direction orientation of the installation in series creates movement and enables areas of the ceiling and/or the wall to be highlighted. Incontro emits reflected and indirect light and is available with white, matt gold and matt silver finishes and in versions with an on/off and dimmer switch.

Die charakteristische Besonderheit von Incontro sind zwei nach außen gebogene dünne Bänder aus lackiertem Metall, die sich an ihren Enden vereinen. Da das LED-Leuchtmittel aus keinem Blickwinkel sichtbar ist, lässt sich die Leuchte in jeder beliebigen Höhe und Ausrichtung an Wand oder Decke installieren. Eine Reiheninstallation in gleicher oder abwechselnder Ausrichtung ermöglicht einen Welleneffekt an Wand oder Decke zur Betonung einzelner Raumbereiche. Incontro gibt reflektiertes und indirektes Licht aus und ist in den Ausführungen Weiß, Mattgold und Mattsilber sowie auch als dimmbare Leuchte erhältlich.

Incontro est caractérisée par deux langues repliés vers l'extérieur en métal laqué qui se soudent fines et parallèles à leur extrémité. La source led invisible rend possible l'installation au mur et au plafond à n'importe quelle hauteur et direction. L'orientation alternée ou mono-direction des installations en série crée du mouvement et permet d'accentuer des parties du plafond et/ou du mur. Elle émet une lumière réfléchie et indirecte et est disponible dans la finition blanche, or opaque, argent opaque et en version on-off ou dimmerable.

Incontro se caracteriza por dos lenguas extravertidas de metal lacado que convergen, finas y paralelas, en sus extremos. La fuente led, invisible, hace que pueda instalarse en la muralla o en el techo, a cualquier altura y en cualquier dirección. La orientación alternada o mono-dirección de las instalaciones en serie crea movimiento y permite realzar zonas del techo y/o de la pared. Emite luz refleja e indirecta y está disponible en acabados blanco, dorado mate, plateado mate y en versión on-off o regulable con dimmer.

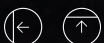

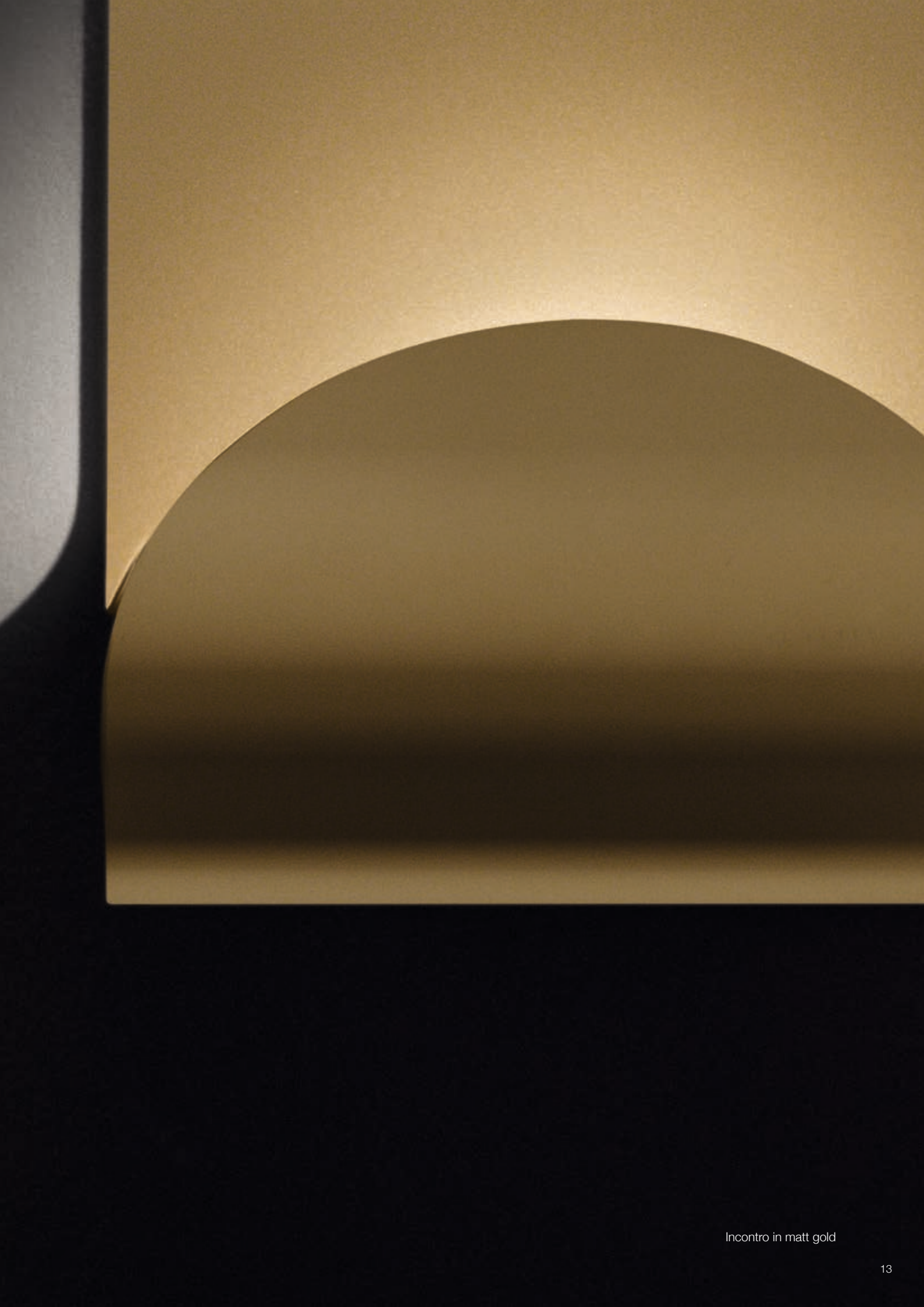









Incontro in white











# Passepartout terra

Luta Bettonica, 2016

Lampada da terra per interni a luce indiretta. Caratterizzata da due anelli in lamiera in finitura lucida, uguali e contrapposti, accoppiati e raccordati allo stelo rettangolare da una struttura in alluminio diamantata per le versioni cromo, nero, bianco e smaltata ottone opaco per la versione ottone. Un sensore di prossimità nello stelo gestisce accensione, spegnimento e dimmerazione con il passaggio e il soffermarsi della mano. Estensione di linea di Passepartout parete.

Passepartout introduces an indoor floor lamp generating indirect lighting, featuring two identical and opposing sheet metal rings with a polished finish, paired and linked to the rectangular cross-section upright by a simple diamond-finished aluminium structure for the chrome, black, white versions and matt enamelled brass for the brass version. A proximity sensor in the upright manages the switching on and off and dimming functions when a hand is moved or stays still in the vicinity. An extension of the Passepartout wall collection.

Stehlampe mit Indirektlicht. Gekennzeichnet durch zwei gleich große, gegenüberliegende Ringe aus glanzpoliertem Stahlblech, die über ein Tragelement aus diamantgeschliffenem Aluminium mit dem rechteckigen Schaft verbunden sind. Ausführungen: Chrom, Schwarz und Weiß sowie Messing matt emailliert bei der Messingausführung. Dank eines Näherungssensors im Schaft lässt sich die Leuchte durch einfache Berührung ein- und ausschalten sowie dimmen. Programmweiterung für Passepartout parete.

Lampe de terre pour intérieurs à lumière indirecte. Caractérisée par deux anneaux en tôle en finition brillante, égaux et opposés, accouplés et raccordés à la tige rectangulaire par une structure en aluminium diamanté pour la version chrome, noire, blanche et émaillée laiton opaque pour la version laiton. Un capteur de proximité dans la tige gère l'enclenchement/déclenchement et la dimmeration au passage et à l'approche de la main. C'est une extension de la ligne de Passepartout à mur.

Lámpara de pie para interiores de luz indirecta. Caracterizada por dos anillos de chapa con acabado brillante, iguales y contrapuestos, acoplados y unidos al pie rectangular por una estructura de aluminio adiamantado para las versiones cromo, negro, blanco y esmaltada latón mate para la versión latón. Un sensor de proximidad puesto en el pie de la lámpara permite encender, apagar o regular la intensidad de la luz simplemente pasando o deteniendo la mano cerca de él. Extensión de línea de Passepartout pared.





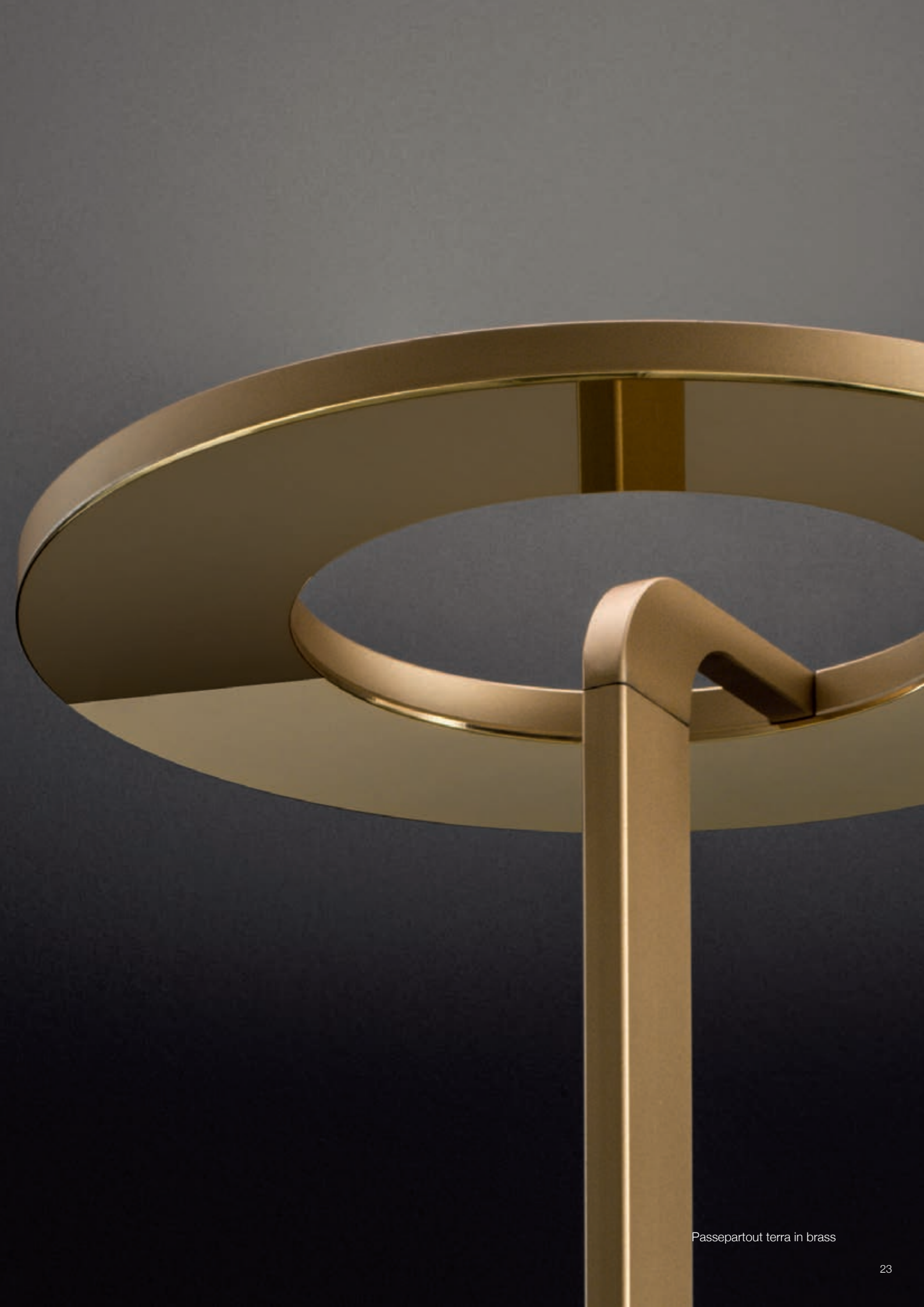

Passepartout terra in brass



Passepartout terra in brass



Passepartout terra in chrome





Passepartout terra in brass, chrome,  
white enamel, black enamel

# Assolo

Luta Bettonica, 2013

La famiglia Assolo si arricchisce delle nuove finiture nero opaco e oro opaco. Il nero profondo valorizza l'essenzialità del cerchio perfetto con un segno grafico netto e definito. L'oro opaco ne accentua la classicità della forma, scalda e valorizza l'ambiente con raffinatezza. Le due finiture convivono con eleganza anche in combinazione tra loro.

The Assolo family is adding new matt black and matt gold finishes. The deep black emphasises the understatement of the perfect circle with a clear, well-defined graphic sign. The matt gold accentuates its classical form, adding warmth and value to the interior with a touch of class. The two finishes can also cohabit elegantly in combination with each other.

Die Familie Assolo wird durch die neuen Ausführungen Mattschwarz und Mattgold erweitert. Das tiefe Schwarz hebt die essenzielle Schlichtheit der perfekten Ringform hervor. Die Mattgold-Ausführung betont die klassische Form, während sie dem umgebenden Raum Wärme und Eleganz verleiht. Die beiden Ausführungen lassen sich auch stilvoll miteinander kombinieren.

La famille Assolo s'enrichit de nouvelles finitions noir opaque et or opaque. Le noir total valorise l'essentialité de la circonference parfaite avec un signe graphique net et défini. L'or opaque accentue le classicisme de la forme et réchauffe l'ambiance en la valorisant avec son charme. Les deux finitions cohabitent avec élégance même en combinaison entre elles.

La familia Assolo se enriquece de nuevos acabados negro mate y dorado mate. El negro profundo valoriza la esencialidad del círculo perfecto con un signo gráfico neto y definido. El dorado mate acentúa lo clásico de la forma, valoriza y hace más cálido el ambiente con distinción. Los dos acabados conviven con elegancia incluso cuando se combinan entre ellos.



Assolo43 sospesa in black,  
Assolo70 sospesa in matt gold







Assolo43 soffitto in matt gold  
Assolo70 terra in black

# Cuboled

Franco Bettonica, Mario Melocchi 1972-2013

Cuboled e Cuboluce sono disponibili in diverse finiture, ultima novità è la finitura gold. La perfetta geometria del cubo incontra l'eleganza senza tempo dell'oro opaco.

Cuboled and Cuboluce are available with a variety of finishes: the latest new entry is the gold finish. The cube's perfect geometry meets the timeless elegance of matt gold.

Die Würfelleuchten Cuboled und Cuboluce sind in zahlreichen Ausführungen erhältlich. Hinzugekommen ist nun der Gold-Look. Die perfekt geometrische Würfelform vereint sich hier mit der zeitlosen Eleganz des Mattgolds.

Cuboled et Cuboluce sont disponibles en différentes finitions, la finition gold est la dernière nouveauté. La géométrie parfaite du cube rencontre l'élégance intemporelle de l'or opaque.

Cuboled y Cuboluce están disponibles en varios acabados, última novedad es el acabado gold. La perfecta geometría del cubo encuentra la elegancia sin tiempo del dorado mate.





Cuboled in matt gold





# miniTensoSferico

Luta Bettonica, 2016

miniTensoApparecchio LED su cavi a 230V a doppia emissione per luce diretta e indiretta. Disponibile in versione bianco e argento, è corredato da calotte in polycarbonato trasparente con lenti concentranti per luce puntuale oppure da calotte in polycarbonato opalescente per luce diffusa. L'elegante forma sferica di soli 14 cm è ideale in piccoli e medi ambienti. Apparecchio munito di TensoClic, connettore brevettato a perforazione d'isolante.

miniTensoApparecchio LED is a 230V cable-mounted fitting with dual emission for direct and indirect light. Available in white and silver versions, it comes with a transparent polycarbonate cap with focusing lenses for accent lighting or with an opalescent polycarbonate cap for diffused light. Measuring only 14 cm across, the elegant sphere is ideal for small and medium-sized interiors. The luminaire is fitted with TensoClic, the patented insulation-piercing connector.

LED-miniTensoLeuchte an 230V-Spannkabeln, mit zweifacher Lichtausgabe für Direkt- und Indirektlicht. Erhältlich in den Ausführungen Weiß und Silber und ausgestattet mit Halbkugeln aus transparentem Polycarbonat mit Linsen für Punktlicht bzw. mit Halbkugeln aus halbtransparentem Polycarbonat für Streulicht. Die elegante Kugelform von nur 14 cm Durchmesser ist ideal für kleine bis mittelgroße Räume. Mit TensoClic, dem patentierten, die Kabelisolierung durchdringenden Steckanschluss.

miniTensoApparecchio LED sur câbles 230V à double émission pour un éclairage direct et indirect. Il est disponible en version blanche et argent, et fourni de calottes en polycarbonate transparent avec lentilles concentrantes pour un éclairage ponctuel ou de calottes en polycarbonate opalescent pour un éclairage diffus. L'élegante forme sphérique de seulement 14 cm est idéale pour le décor de petits ou moyens espaces. Appareil équipé de TensoClic, connecteur breveté à perforation d'isolation.

miniTensoApparecchio LED sobre cables de 230V de doble emisión para luz directa e indirecta. Disponible en versión de color blanco y plateado, está provisto de casquetes de polycarbonato transparente con lentes que concentran los rayos de luz para una luz puntual o de casquetes de polycarbonato opalescente para luz difusa. La elegante forma esférica de solo 14 cm es ideal en ambientes pequeños y medianos. Aparato provisto de TensoClic, conector patentado que perfora el aislante.





miniTensoSferico trasparente in silver



miniTensoSferico opalescente in white





miniTensoSferico trasparente in silver





miniTensoSferico opalescente in silver

# TensoStilo

Luta Bettonica, 2016

TensoApparecchio LED a tensione di rete senza alimentatore, su cavi a 230V, composto da un corpo illuminante a doppia emissione per un'illuminazione diretta e indiretta diffusa. Forma essenziale, lineare, adatta ad ambienti contract. TensoStilo è disponibile in finitura bianco e argento con diffusori in metacrilato opalescente. Apparecchio munito di TensoClic, connettore brevettato a perforazione d'isolante.

TensoApparecchio LED is a cable-mounted fitting that takes 230V mains voltage, needs no supply unit and comprises a dual emission lighting body for combined direct and indirect diffused lighting. Its uncluttered linear form is well suited to contract interiors.

TensoStilo is available in a choice of white or silver finishes, with opalescent methacrylate diffusers. The luminaire is fitted with TensoClic, the patented insulation-piercing connector.

LED-TensoLeuchte mit Netzspannung ohne Transformator, an 230V-Spannkabeln, bestehend aus einem Leuchtenkörper mit zweifacher Lichtausgabe für Direkt- und Indirekt-/Streulicht. Die schlichte, lineare Form eignet sich gut für den Objektbereich. TensoStilo ist in den Ausführungen Weiß und Silber mit Lichtverteiler aus halbdurchsichtigem Methacrylat erhältlich. Mit TensoClic, dem patentierten, die Kabelisolierung durchdringenden Steckanschluss.

TensoApparecchio LED, à tension de secteur sans ballast, sur câbles 230V, composé d'un corps éclairant à double émission pour un éclairage direct et indirect diffus. Forme essentielle, linéaire, approprié pour une ambiance contract. TensoStilo est disponible en finition blanche et argentée avec diffuseurs en méthacrylate opalescent. Appareil équipé de TensoClic, connecteur breveté à perforation d'isolation.

TensoApparecchio LED con tensión de red sin alimentador, sobre cables de 230V, compuesto por un cuerpo iluminante de doble emisión para una iluminación directa e indirecta difusa. Forma esencial, lineal, adecuada para ambientes contract. TensoStilo está disponible con acabado blanco y plateado con difusores en metacrilato opalescente. Aparato provisto de TensoClic, conector patentado que perfora el aislante.



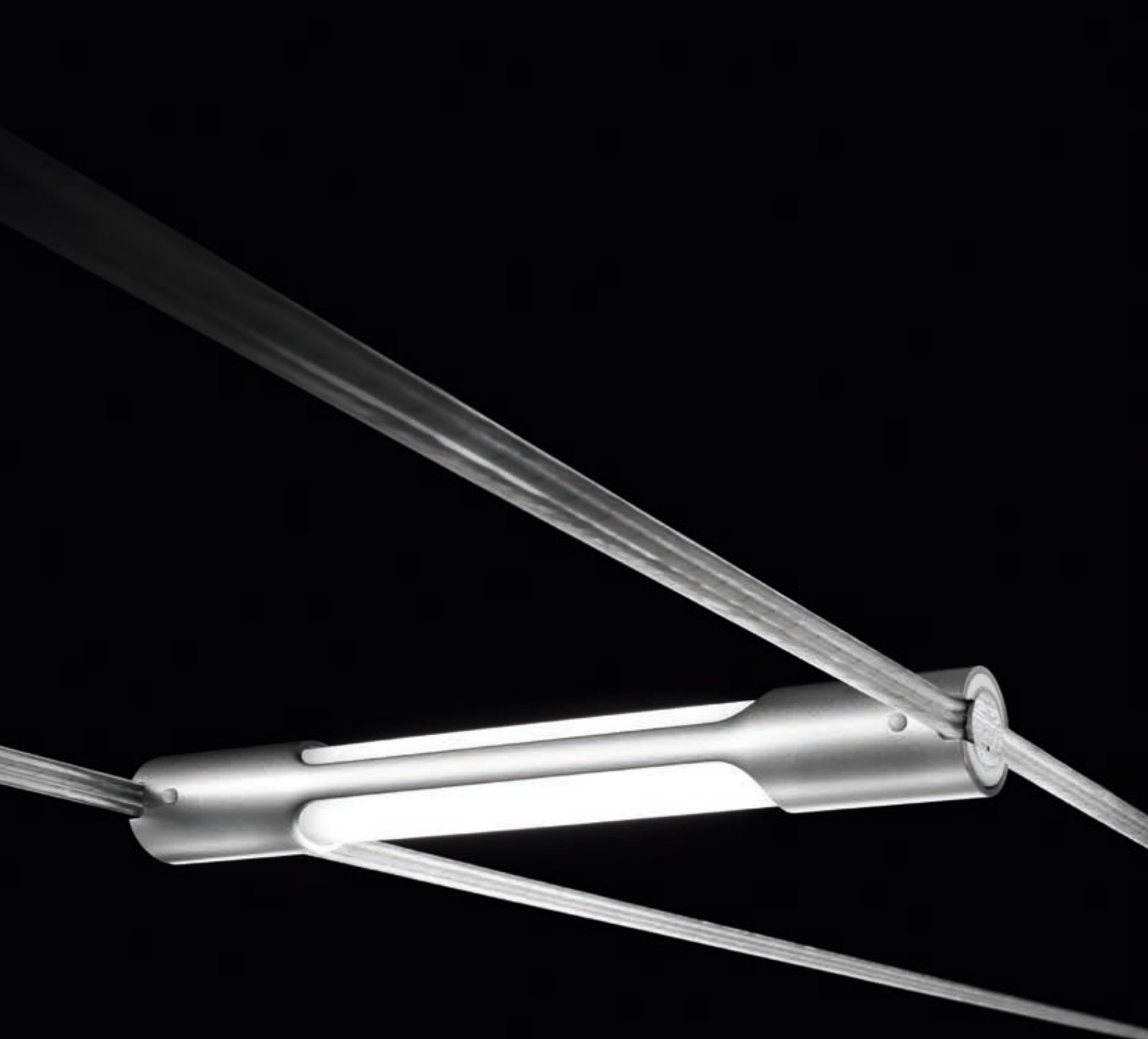





TensoStilo in white



TensoStilo in silver



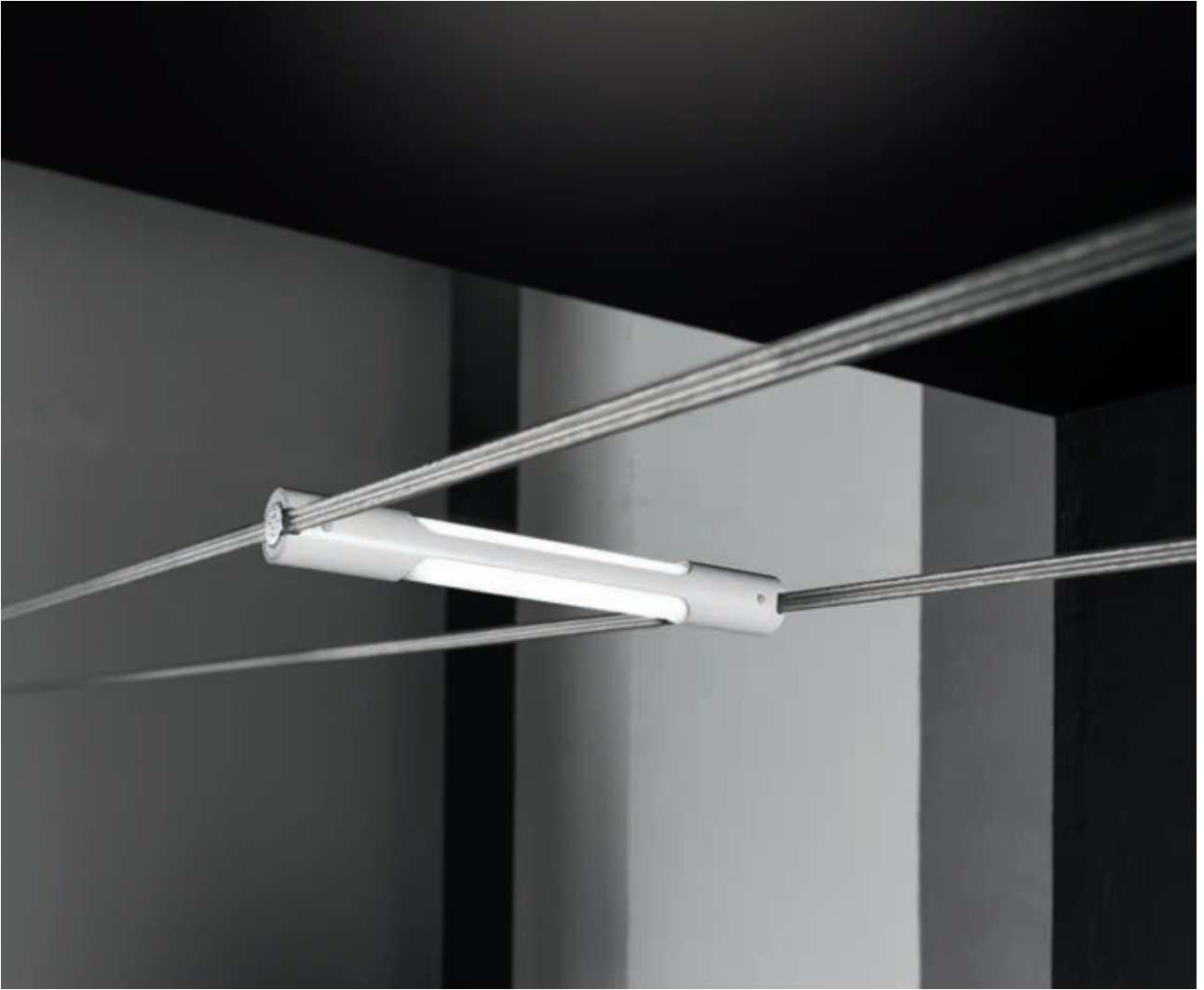

TensoStilo in white



# Schede tecniche

## Technical sheets

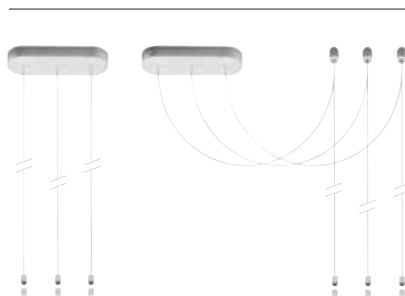
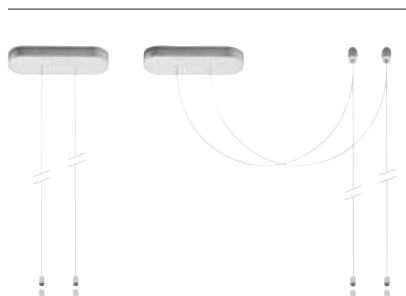
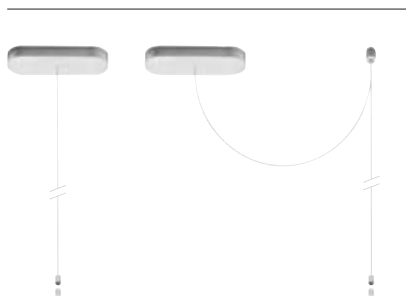

## Acqua uno rosone

470 bianco / white / weiß / blanc / blanco

G470 oro opaco / matt gold / Gold matt /  
or mat / oro mate

S470 argento opaco / matt silver / Silber matt /  
argent mat / plata mate

### — on demand

foglia oro o foglia argento / gold leaf or silver  
leaf / Blattgold oder Blattsilber / feuille d'or  
ou feuille d'argent / choja de oro o hoja  
de plata

## Acqua uno decentrata rosone

471 bianco / white / weiß / blanc / blanco

G471 oro opaco / matt gold / Gold matt /  
or mat / oro mate

S471 argento opaco / matt silver / Silber matt /  
argent mat / plata mate

### — on demand

foglia oro o foglia argento / gold leaf or silver  
leaf / Blattgold oder Blattsilber / feuille d'or  
ou feuille d'argent / choja de oro o hoja  
de plata

CE IP20

kg 1,2

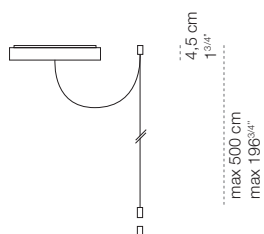
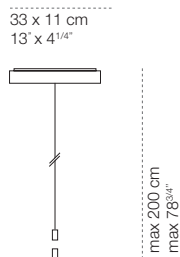

## Acqua due rosone

469 bianco / white / weiß / blanc / blanco

G469 oro opaco / matt gold / Gold matt /  
or mat / oro mate

S469 argento opaco / matt silver / Silber matt /  
argent mat / plata mate

### — on demand

foglia oro o foglia argento / gold leaf or silver  
leaf / Blattgold oder Blattsilber / feuille d'or  
ou feuille d'argent / choja de oro o hoja  
de plata

## Acqua due decentrata rosone

472 bianco / white / weiß / blanc / blanco

G472 oro opaco / matt gold / Gold matt /  
or mat / oro mate

S472 argento opaco / matt silver / Silber matt /  
argent mat / plata mate

### — on demand

foglia oro o foglia argento / gold leaf or silver  
leaf / Blattgold oder Blattsilber / feuille d'or  
ou feuille d'argent / choja de oro o hoja  
de plata

CE IP20

kg 1,25

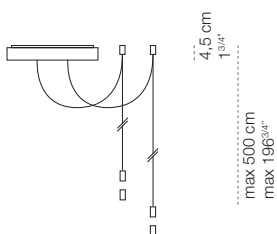
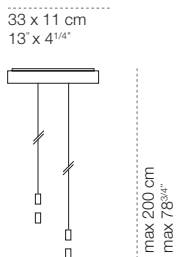

## Acqua tre rosone

468 bianco / white / weiß / blanc / blanco

G468 oro opaco / matt gold / Gold matt /  
or mat / oro mate

S468 argento opaco / matt silver / Silber matt /  
argent mat / plata mate

### — on demand

foglia oro o foglia argento / gold leaf or silver  
leaf / Blattgold oder Blattsilber / feuille d'or  
ou feuille d'argent / choja de oro o hoja  
de plata

## Acqua tre decentrata rosone

473 bianco / white / weiß / blanc / blanco

G473 oro opaco / matt gold / Gold matt /  
or mat / oro mate

S473 argento opaco / matt silver / Silber matt /  
argent mat / plata mate

### — on demand

foglia oro o foglia argento / gold leaf or silver  
leaf / Blattgold oder Blattsilber / feuille d'or  
ou feuille d'argent / choja de oro o hoja  
de plata

CE IP20

kg 1,3

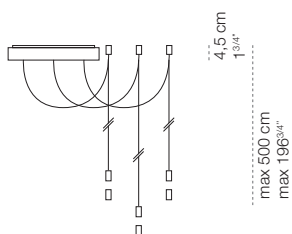
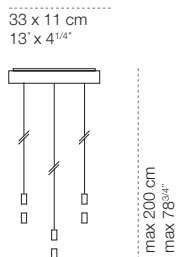



**Acqua corpo illuminante uplight CRI ≥ 80**

**460** bianco / white / weiß / blanc / blanco

**G460** oro opaco / matt gold / Gold matt / or mat / oro mate

**S460** argento opaco / matt silver / Silber matt / argent mat / plata mate

**— on demand**

foglia oro o foglia argento / gold leaf or silver leaf / Blattgold oder Blattsilber / feuille d'or ou feuille d'argent / choja de oro o hoja de plata

led 5,6W  
650 lm / 2.800K / dimmable / push button

**Acqua corpo illuminante uplight CRI = 95**

**460H** bianco / white / weiß / blanc / blanco

**G460H** oro opaco / matt gold / Gold matt / or mat / oro mate

**S460H** argento opaco / matt silver / Silber matt / argent mat / plata mate

**— on demand**

foglia oro o foglia argento / gold leaf or silver leaf / Blattgold oder Blattsilber / feuille d'or ou feuille d'argent / choja de oro o hoja de plata

led 5,6W  
520 lm / 2.800K / dimmable / push button

Luce indiretta / Indirect light / Indirektes Licht / Lumière indirecte / Luz indirecta

energy label type 1 (p.61)

CE IP20

kg 0,4



11 cm 10 cm  
4 1/4" 4"

**Acqua corpo illuminante downlight CRI ≥ 80**

**459** bianco / white / weiß / blanc / blanco

**G459** oro opaco / matt gold / Gold matt / or mat / oro mate

**S459** argento opaco / matt silver / Silber matt / argent mat / plata mate

**— on demand**

foglia oro o foglia argento / gold leaf or silver leaf / Blattgold oder Blattsilber / feuille d'or ou feuille d'argent / choja de oro o hoja de plata

led 5,6W  
650 lm / 2.800K / dimmable / push button

**Acqua corpo illuminante uplight CRI = 95**

**459H** bianco / white / weiß / blanc / blanco

**G459H** oro opaco / matt gold / Gold matt / or mat / oro mate

**S459H** argento opaco / matt silver / Silber matt / argent mat / plata mate

**— on demand**

foglia oro o foglia argento / gold leaf or silver leaf / Blattgold oder Blattsilber / feuille d'or ou feuille d'argent / choja de oro o hoja de plata

led 5,6W  
520 lm / 2.800K / dimmable / push button

Luce diretta / Direct light / Direktes Licht / Lumière directe / Luz directa

energy label type 1 (p.61)

CE IP20

kg 0,4

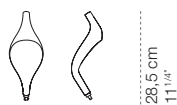

11 cm 10 cm  
4 1/4" 4"

**Acqua rosone incasso (1)**

**452** bianco / white / weiß / blanc / blanco

**G452** oro opaco / matt gold / Gold matt / or mat / oro mate

**S452** argento opaco / matt silver / Silber matt / argent mat / plata mate

**— on demand**

foglia oro o foglia argento / gold leaf or silver leaf / Blattgold oder Blattsilber / feuille d'or ou feuille d'argent / choja de oro o hoja de plata



**Acqua rosone remoto (2)**

**461** bianco / white / weiß / blanc / blanco

**G461** oro opaco / matt gold / Gold matt / or mat / oro mate

**S461** argento opaco / matt silver / Silber matt / argent mat / plata mate

**— on demand**

foglia oro o foglia argento / gold leaf or silver leaf / Blattgold oder Blattsilber / feuille d'or ou feuille d'argent / choja de oro o hoja de plata

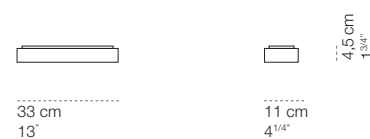

Per gli accessori "cavo rosone remoto" e "guida cavo" vedere catalogo generale pag. 252 / See page 252 general catalogue for "cavo rosone remoto" and "guida cavo" accessories / Für die Zubehör "cavo rosone remoto" und "guida cavo" siehe Seite 252 des Gesamtkatalog / Pour les accessoires "cavo rosone remoto" et "guida cavo" voir le catalogue général pag. 252 / Para los accesorios "cavo rosone remoto" y "guida cavo" consulte el catálogo general pág. 252

# Incontro

/ Luta Bettonica, 2015



## Incontro parete|soffitto

**410** bianco / white / weiß / blanc / blanco

**411** oro opaco / matt gold / Gold matt /  
or mat / oro mate

**412** argento opaco / matt silver / Silber matt /  
argent mat / plata mate

led 15W  
1.700 lm / 2.800K / CRI = 90 / dimmable /  
phase-cut

Luce indiretta / Indirect light / Indirektes Licht /  
Lumière indirecte / Luz indirecta

energy label type 1 (p.61)

CE IP20

kg 1,15

## Incontro ON/OFF parete|soffitto

**413** bianco / white / weiß / blanc / blanco

**414** oro opaco / matt gold / Gold matt /  
or mat / oro mate

**415** argento opaco / matt silver / Silber matt /  
argent mat / plata mate

led 13W  
1.800 lm / 2.800K / CRI ≥ 80 / not dimmable

Luce indiretta / Indirect light / Indirektes Licht /  
Lumière indirecte / Luz indirecta

energy label type 1 (p.61)

CE IP20

kg 1,15



21,5 cm  
8<sup>1/2</sup>"



21,5 cm  
8<sup>1/2</sup>"

7,5 cm  
3"



21,5 cm  
8<sup>1/2</sup>"

21,5 cm  
8<sup>1/2</sup>"

7,5 cm  
3"

# Passepartout

/ Luta Bettonica, 2016



## Passepartout terra bianco

**1171** anelli e stelo smalto bianco lucido, struttura alluminio diamantato e satinato / rings and stem in polished white enamel, structure in satin and diamond-finished aluminium / Ringe und Schaft mit weißer Hochglanz-Emaillackierung, Tragelement aus Aluminium, diamantgeschliffen und satiniert / anneaux et tige en émail blanc brillant, structure en aluminium diamanté et satiné / anillos y pie en esmalte blanco brillante, estructura de aluminio adiamantado y satinado

## Passepartout terra cromo

**1170** anelli cromo lucido, stelo e struttura acciaio satinato e alluminio diamantato / rings in polished chrome, stem and structure in satin-finish steel and diamond-finished aluminium / Ringe glanzverchromt, Schaft und Tragelement aus satiniertem Stahl und diamantgeschliffenem Aluminium / anneaux en chrome brillant, tige et structure en acier satiné et aluminium diamanté / anillos de cromo brillante, pie y estructura de acero satinado y aluminio adiamantado

## Passepartout terra ottone

**1173** anelli ottone lucido, stelo e struttura ottone smalto opaco / rings in polished brass, stem and structure in matt brass enamel / Ringe aus glanzpoliertem Messing, Schaft und Tragelement mit matter Messing-Emaillackierung / anneaux en laiton brillant, tige et structure en émail laiton opaque / anillos de latón brillante, pie y estructura en esmalte latón mate

led 35W  
3.600 lm / 2.800K / CRI = 92 / integrated touchless dimmer

Luce indiretta / Indirect light / Indirektes Licht /  
Lumière indirecte / Luz indirecta

energy label type 1 (p.61)

CE IP20

kg 7,0

## Passepartout terra nero

**1172** anelli e stelo smalto nero lucido, struttura alluminio diamantato e satinato / rings and stem in polished black enamel, structure in satin and diamond-finished aluminium / Ringe und Schaft mit schwarzer Hochglanz-Emaillackierung, Tragelement aus Aluminium, diamantgeschliffen und satiniert / anneaux et tige en émail noir brillant, structure en aluminium diamanté et satiné / anillos y pie en esmalte negro brillante, estructura de aluminio adiamantado y satinado

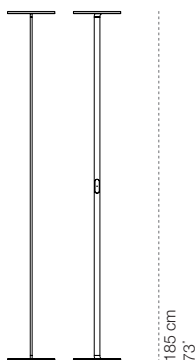

Ø 25 cm  
Ø 9<sup>7/8</sup>

# Assolo / Luta Bettonica, 2013



## Assolo parete|soffitto

**1554** oro opaco / matt gold / Gold matt / or mat / oro mate

**1555** oro opaco con piastra tonda / matt gold with round wall plate / Gold matt mit runder Wandplatte / or mat avec ronde plaque mural / oro mate con placa redonda

led 16W  
1.300 lm / 2.800K / CRI ≥ 80 / dimmable / phase cut

Luce indiretta / Indirect light / Indirektes Licht / Lumière indirecte / Luz indirecta

energy label type 1 (p.61)  
CE IP20

kg 0,8

### Junction box plate (optional) \*

**1558** oro opaco / matt gold / Gold matt / or mat / oro mate

## Assolo ON/OFF parete|soffitto

**1556** oro opaco / matt gold / Gold matt / or mat / oro mate

**1557** oro opaco con piastra tonda / matt gold with round wall plate / Gold matt mit runder Wandplatte / or mat avec ronde plaque mural / oro mate con placa redonda

led 16W  
1.300 lm / 2.800K / CRI ≥ 80 / not dimmable

Luce indiretta / Indirect light / Indirektes Licht / Lumière indirecte / Luz indirecta

energy label type 1 (p.61)  
CE IP20

kg 0,8

### Junction box plate (optional) \*

**1558** oro opaco / matt gold / Gold matt / or mat / oro mate

## Assolo43 sospesa

**G1566** oro opaco / matt gold / Gold matt / or mat / oro mate

**1563H** nero / black / schwarz / noir / negro

led 27W  
2.100 lm / 2.800K / CRI = 92 / dimmable / phase cut

Luce indiretta / Indirect light / Indirektes Licht / Lumière indirecte / Luz indirecta

energy label type 1 (p.61)  
CE IP20

kg 3,5

### Piastra tonda (optional) \*\*

**G1569** oro opaco / matt gold / Gold matt / or mat / oro mate

**B1569** nero / black / schwarz / noir / negro

Per le altre finiture vedi catalogo generale pag. 264 / For other finishes see general catalogue page 264 / Für die andere Ausführungen siehe Gesamtkatalog Seite 264 / Pour les autres finitions voir le catalogue général pag. 264 / Para los otros acabados consulte el catálogo general pág. 264

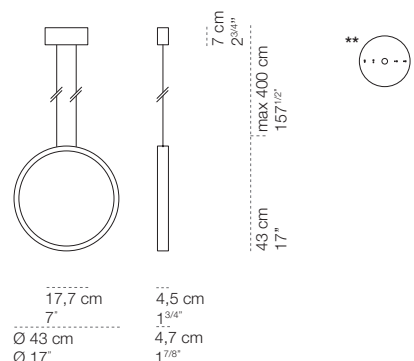
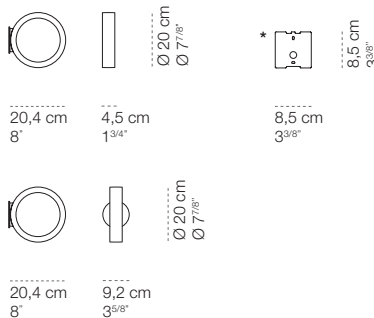
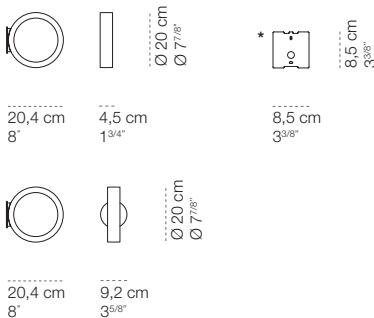

\* piastra per scatole di derivazione (anche Olanda) con interasse fori 8,1 cm / lid for junction box (also for Netherlands) with holes set at 8.1 cm intervals / Abdeckplatte für Abzweigkasten (selbst Nederland) mit Lochabstand 8,1 cm / plaque pour boîtes de dérivation (même Olanda) avec entraxe 8,1 cm / plancha para cajas de derivación (incluido Holanda) con intreeje orificios de 8,1 cm





**Assolo70** sospesa

**G1571** oro opaco / matt gold / Gold matt / or mat / oro mate

**1574H** nero / black / schwarz / noir / negro

led 27W  
2.900 lm / 2.800K / CRI = 92 / dimmable / phase cut

Luce indiretta / Indirect light / Indirektes Licht /  
Lumière indirecte / Luz indirecta

energy label type 1 (p.61)

CE IP20

kg 5,4

**Piastra tonda** (optional) \*\*

**G1569** oro opaco / matt gold / Gold matt / or mat / oro mate

**B1569** nero / black / schwarz / noir / negro



**Assolo43** soffitto

**G1565** oro opaco / matt gold / Gold matt / or mat / oro mate

**1562H** nero / black / schwarz / noir / negro

led 27W  
2.900 lm / 2.800K / CRI = 92 / dimmable / phase cut

Luce indiretta / Indirect light / Indirektes Licht /  
Lumière indirecte / Luz indirecta

energy label type 1 (p.61)

CE IP20

kg 3,0

**Piastra tonda** (optional) \*\*

**G1569** oro opaco / matt gold / Gold matt / or mat / oro mate

**B1569** nero / black / schwarz / noir / negro



**Assolo70** soffitto

**G1570** oro opaco / matt gold / Gold matt / or mat / oro mate

**1564H** nero / black / schwarz / noir / negro

led 27W  
2.900 lm / 2.800K / CRI = 92 / dimmable / phase cut

Luce indiretta / Indirect light / Indirektes Licht /  
Lumière indirecte / Luz indirecta

energy label type 1 (p.61)

CE IP20

kg 4,9

**Piastra tonda** (optional) \*\*

**G1569** oro opaco / matt gold / Gold matt / or mat / oro mate

**B1569** nero / black / schwarz / noir / negro

Per le altre finiture vedi catalogo generale pag. 264 / For other finishes see general catalogue page 264 / Für die andere Ausführungen siehe Gesamtkatalog Seite 264 / Pour les autres finitions voir le catalogue général pag. 264 / Para los otros acabados consulte el catálogo general pág. 264

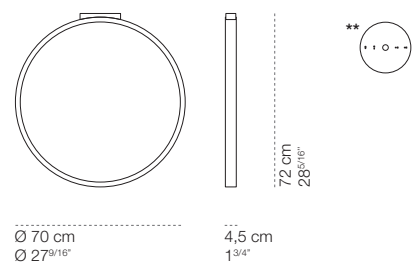
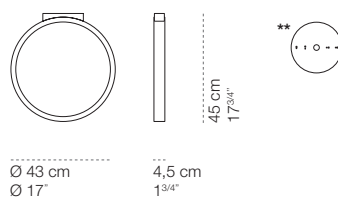
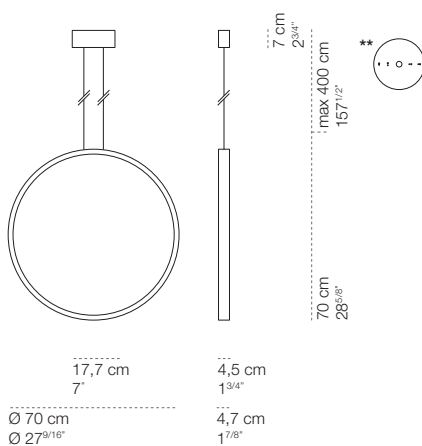

\*\* Ø 18 cm / 7 1/8"

*piastra per scatole di derivazione (anche Olanda) con interasse fori 8,1 cm / lid for junction box (also for Netherlands) with holes set at 8.1 cm intervals / Abdeckplatte für Abzweigkasten (selbst Nederland) mit Lochabstand 8,1 cm / plaque pour boîtes de dérivation (même Olanda) avec entraxe 8,1 cm / plancha para cajas de derivación (incluido Holanda) con intreeje orificios de 8,1 cm*



## Assolo70 terra

**G1572** oro opaco / matt gold / Gold matt /  
or mat / oro mate

led 27W  
2.900 lm / 2.800K / CRI = 92 / in-line dimmer

Luce indiretta / Indirect light / Indirektes Licht /  
Lumière indirecte / Luz indirecta

energy label type 1 (p.61)

CE IP20

kg 6,3



## Assolo43 appoggio CRI ≥ 80

**G1567** oro opaco / matt gold / Gold matt /  
or mat / oro mate

led 27W  
2.900 lm / 2.800K / CRI = 92 / in-line dimmer

Luce indiretta / Indirect light / Indirektes Licht /  
Lumière indirecte / Luz indirecta

energy label type 1 (p.61)

CE IP20

kg 4,4



## Assolo appoggio

**1559** oro opaco / matt gold / Gold matt /  
or mat / oro mate

led 10W  
1.000 lm / 2.800K / CRI ≥ 80 / touch dimmer

Luce indiretta / Indirect light / Indirektes Licht /  
Lumière indirecte / Luz indirecta

energy label type 1 (p.61)

CE IP20

kg 0,9

Per le altre finiture vedi catalogo generale pag. 264 / For other finishes see general catalogue page 264 / Für die andere Ausführungen siehe Gesamtkatalog Seite 264 / Pour les autres finitions voir le catalogue général pag. 264 / Para los otros acabados consulte el catálogo general pág. 264

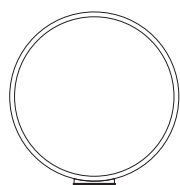

Ø 70 cm  
Ø 27<sup>9/16</sup>"

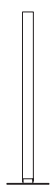

17,5 cm  
6<sup>7/8</sup>"

72 cm  
28<sup>3/16</sup>"

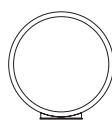

Ø 43 cm  
Ø 17"



17,5 cm  
6<sup>7/8</sup>"

45 cm  
17<sup>3/4</sup>"



Ø 20 cm  
Ø 7<sup>7/8</sup>"



9,5 cm  
3<sup>3/4</sup>"

20,7 cm  
8<sup>1/7</sup>"

# Cuboled, Cuboluce

/ Franco Bettonica, Mario Melocchi, 1972-2013



## Cuboled oro opaco\*

**249L** oro opaco / matt gold / Gold matt /  
or mat / oro mate  
with European plug

**U249L** oro opaco / matt gold / Gold matt /  
or mat / oro mate  
with UK plug

Luce indiretta / Indirect light / Indirektes Licht /  
Lumière indirecte / Luz indirecta

led 2W  
2.700K / CRI = 90

energy label type 1 (p.61)

CE ENEC IP20

kg 0,5

## Cuboluce oro opaco\*

**249** oro opaco / matt gold / Gold matt /  
or mat / oro mate  
with European plug

**U249** oro opaco / matt gold / Gold matt /  
or mat / oro mate  
with UK plug

Luce indiretta / Indirect light / Indirektes Licht /  
Lumière indirecte / Luz indirecta

E14 led 3W  
2.700K / CRI ≥ 80

 bulb included

energy label type 3 (p.61)

CE ENEC IP20

kg 0,5

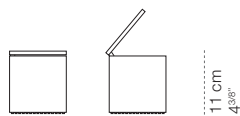

\* also available  
with USA plug  
adapter

10x10 cm  
4x4

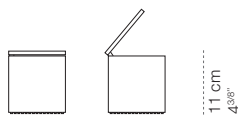

\* also available  
with USA plug  
adapter

10x10 cm  
4x4

# miniTenso

/ Luta Bettonica, 2016



## miniTensoSferico trasparente

**340** bianco / white / weiß / blanc / blanco

**342** argento / silver / Silber / argent / plateado

Luce diretta e indiretta concentrata / Direct and indirect concentrated light / Direktes und indirektes konzentriertes Licht / Lumière directe et indirecte concentrée / Luz directa y indirecta concentrada

led 2x8W  
2x1.100 lm / 2.800K / CRI ≥ 80 / dimmable / phase cut

energy label type 1 (p.61)

CE IP20

kg 0,9

## miniTensoSferico ON/OFF trasparente

**344** bianco / white / weiß / blanc / blanco

**346** argento / silver / Silber / argent / plateado

Luce diretta e indiretta concentrata / Direct and indirect concentrated light / Direktes und indirektes konzentriertes Licht / Lumière directe et indirecte concentrée / Luz directa y indirecta concentrada

led 2x8W  
2x1.100 lm / 2.800K / CRI ≥ 80 / not dimmable

energy label type 1 (p.61)

CE IP20

kg 0,9

## miniTensoSferico opalescente

**341** bianco / white / weiß / blanc / blanco

**343** argento / silver / Silber / argent / plateado

Luce diretta e indiretta diffusa / Direct and indirect diffused light / Direktes und indirektes diffuses Licht / Lumière directe et indirecte diffuse / Luz directa y indirecta difusa

led 2x8W  
2x1.100 lm / 2.800K / CRI ≥ 80 / dimmable / phase cut

energy label type 1 (p.61)

CE IP20

kg 0,9

## miniTensoSferico ON/OFF opalescente

**345** bianco / white / weiß / blanc / blanco

**347** argento / silver / Silber / argent / plateado

Luce diretta e indiretta diffusa / Direct and indirect diffused light / Direktes und indirektes diffuses Licht / Lumière directe et indirecte diffuse / Luz directa y indirecta difusa

led 2x8W  
2x1.100 lm / 2.800K / CRI ≥ 80 / not dimmable

energy label type 1 (p.61)

CE IP20

kg 0,9



Ø 14 cm  
Ø 5 1/2"



16 cm  
6 1/4"

Ø 14 cm  
Ø 5 1/2"

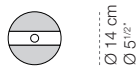

Ø 14 cm  
Ø 5 1/2"

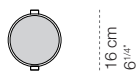

16 cm  
6 1/4"

Ø 14 cm  
Ø 5 1/2"

# Tenso

/ Luta Bettonica, 2016



## TensoStilo

855 bianco / white / weiß / blanc / blanco

856 argento / silver / Silber / argent / plateado

Luce diffusa / Diffused light / Diffuses Licht /  
Lumière diffuse / Luz difusa

led 2x11W

2x1.100 lm / 3.000K / CRI  $\geq$  80 / not dimmable

energy label type 1 (p.61)

CE IP20

kg 0,3



29 cm  
11<sup>3/8</sup>"

Ø 3,5 cm  
Ø 1<sup>3/8</sup>"



# Classe energetica

## Energy label

Type 1

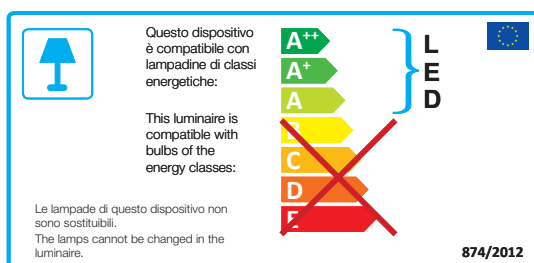

Type 3

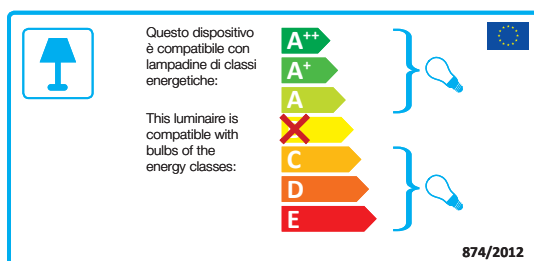

**Cini&Nils srl si riserva la facoltà di apportare modifiche ai prodotti presenti su questo catalogo in qualsiasi momento e senza preavviso.**

Cini&Nils srl reserves the right to make changes on the products on this catalogue at any time and without prior notice.

**I testi e le immagini sono protetti da diritti d'autore.**

**Riproduzione non autorizzata.**

All texts and images are protected by copyright.

Reproduction prohibited.



**A special thanks to**

PoliformVarenna

**Photo product**

varianti.it

**Art Direction**

Valentina Colombo Condivisa&dot

**Print**

Unigrafica S.r.l. Milano, Italia  
03 2017 Milano, Italia

**Copyright © 2017**

**Cini&Nils, Milano, Italia.**





via Polidoro da Caravaggio 37  
20156 Milano Italia

T +39 02 334307.1  
F +39 02 38011010  
info@cinienils.com

cinienils.com

CINI&NILS

